

# Totem Electronics Racks for Seeed Studios Grove Modules.

## For learning and experimenting.

The Grove system has become very popular for building test-and-learning electronics. The system has a wide diversity of electronics modules at a low cost. They are often used together with either Arduinos or Raspberry Pi's. One thing has always followed the creator of electronics when connecting building a circuit : the mess on the table with cables and loose modules floating around. Finally there is an affordable solution to this.

- **From Seeed studios comes the large Grove Beginner Kit with integrated Arduino functionality. Also the Grove Sensor Shield have the same modules and dimensions, but needs an Arduino in addition. Our affordable rack makes these kits become user-friendly and safe to use in school or education situations. Easy storage in shelves and good ergonomics with 45 degrees working angle.**
- **Our rack for general purpose Grove system-building has more brackets for you to snap-on sensors or other Grove modules to a workbench.**

Grove is a Trademark by Seeed Technology Co

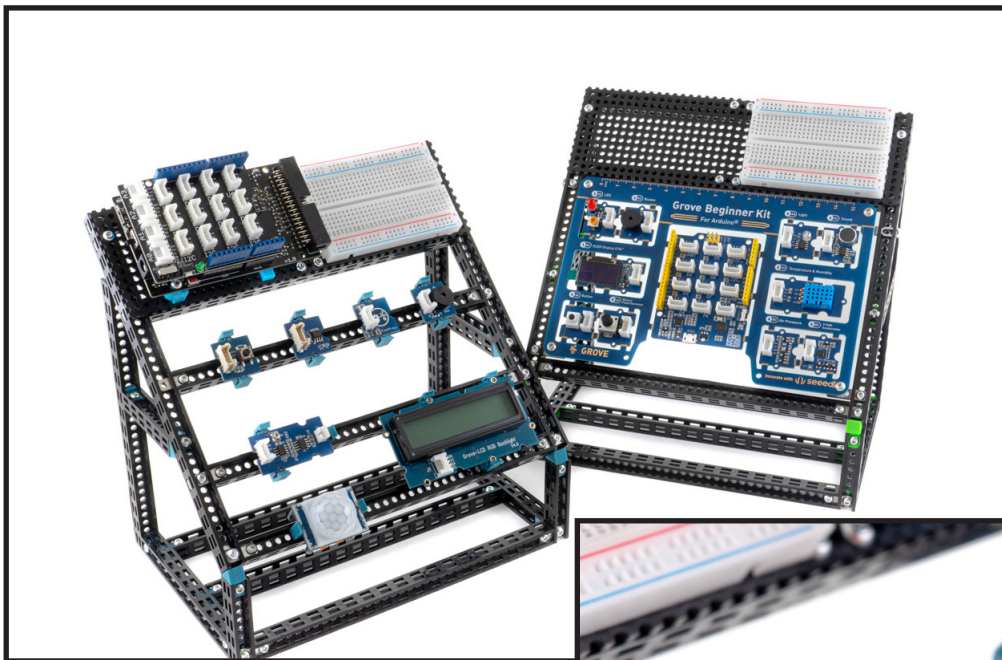

**Tidy up!**

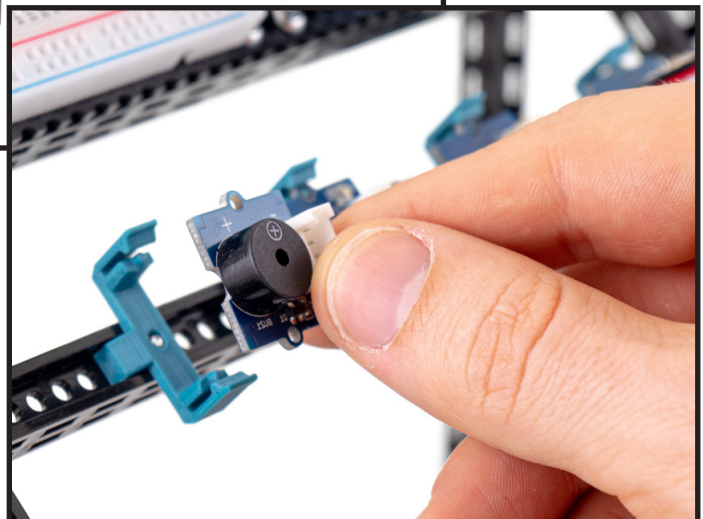

# Snap brackets.

The Grove modules follow a system with 2.2mm mounting holes, fit for using M2 bolts/screws. They are a bit fiddly to use, and isn't easy to be mounted in mechanical constructions. We wanted it to be quick and easy.

- **Arrange any Grove module as you prefer in the rack, snap bracket are easily reorganized**
- **You can fit virtually all kinds of 3rd party electronics to the Totem system too.**

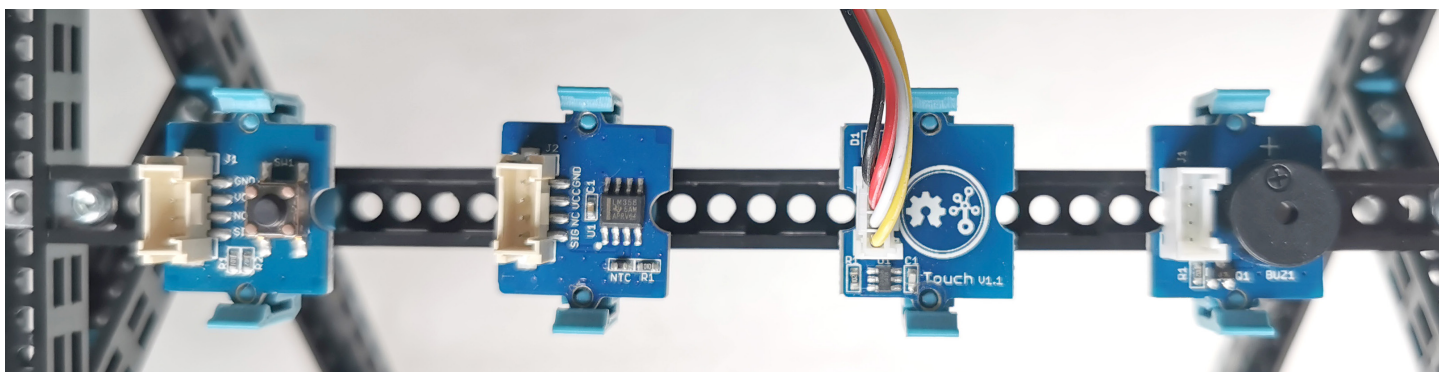
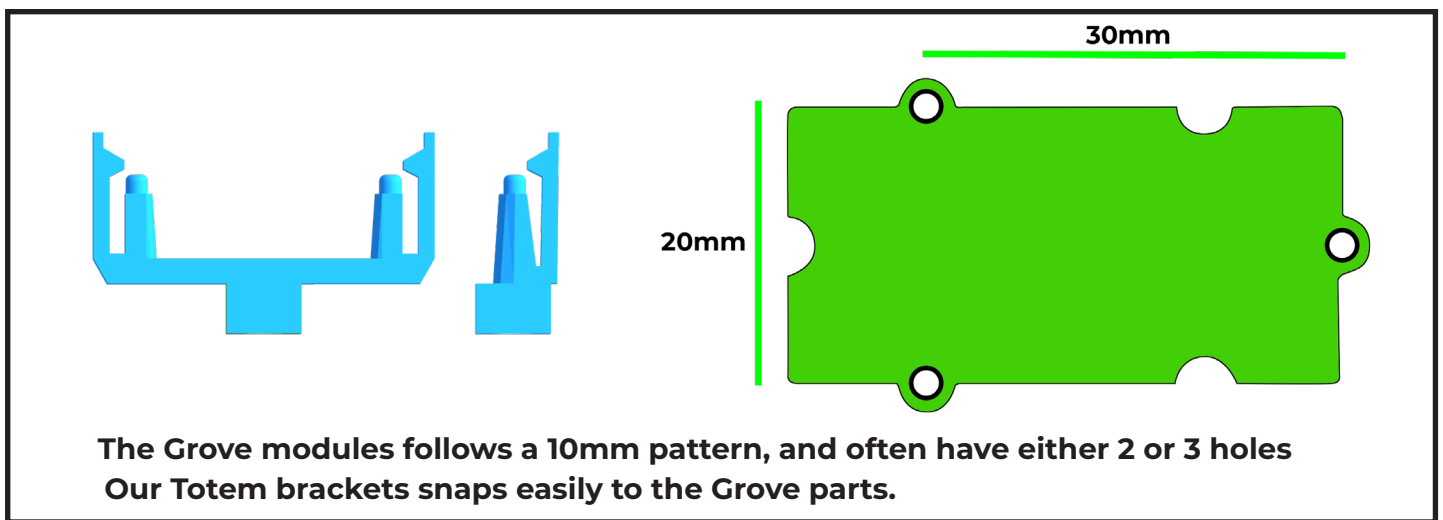

The Grove modules are easily put into Totem beams as shown.

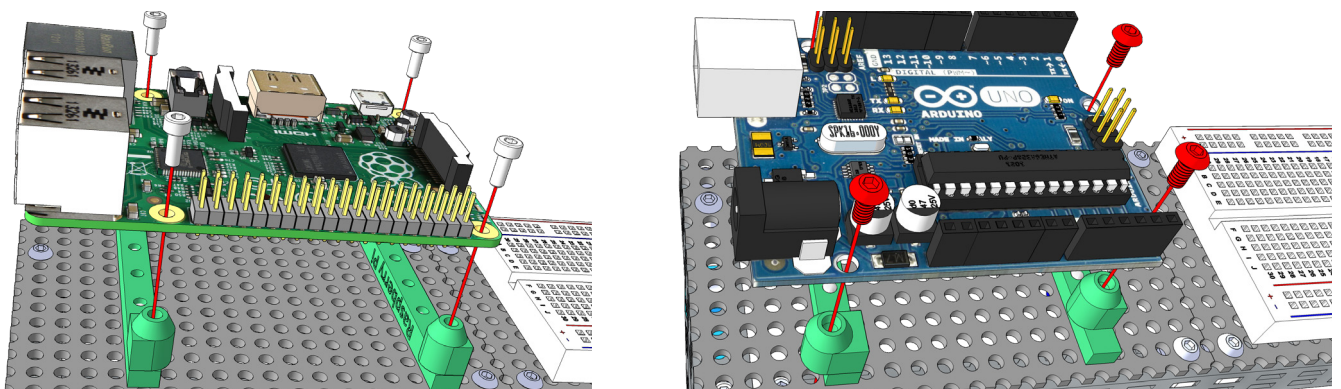

The Grove modules rack includes brackets for Arduinos and Rasberry Pi.

## Ideal for class/education Grove kits.

If you are organizing courses and classes for coding-training or electronics education, you will appreciate to have a tidy setup of the Arduino and module combo. All parts may have a certain place in the rack, or if not, they are easily swapped without any fiddly operation with small screwdrivers.

- **Make class kits ready for use instantly, put away conveniently in shelves between use.**
- **Keep your electronics more safe from short circuiting.**
- **The breadboard is good for extended use in electronics circuits experimentation.**

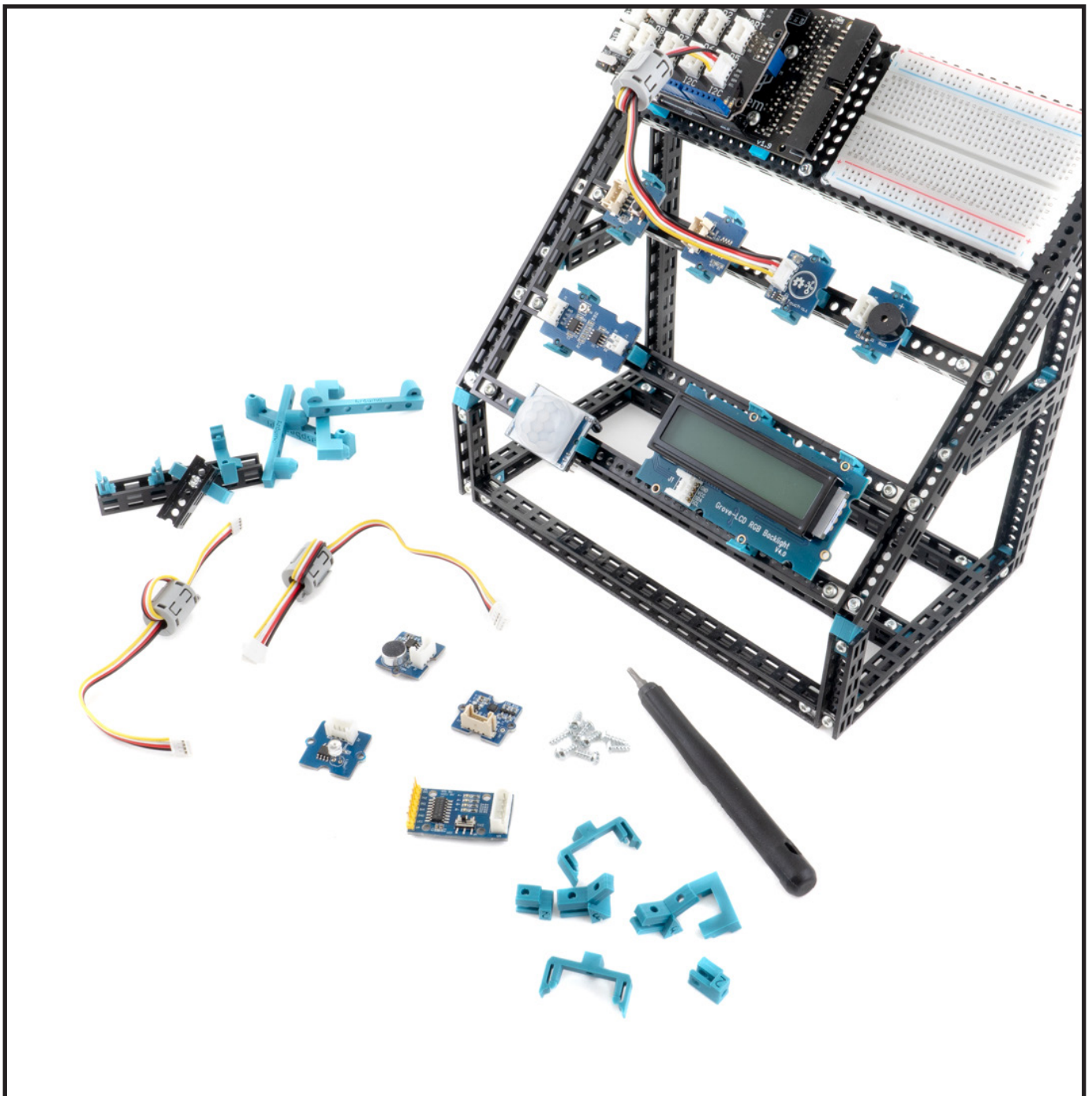



Product code : TKM-GR1

## **Totem rack for Grove modules and Arduino/Raspberry Pi.**

Includes everything you need to build the rack, and several brackets for electronics modules : 7 double and 6 single Grove-module brackets. Brackets for Arduino Uno and Nano. Brackets for Raspberry Pi. No electronics is included.



Product code : TKM-GR2

## **Totem rack for Grove Beginners Kit and Sensor Shield.**

A simpler kit especially made for the Grove Beginners/Sensor Shield Kits. Ideal for school and classes use. No electronics is included.



**AT Totem we create a unique construction system with parts for robotics and electronics prototyping.**

**It's designed as a user-friendly system for makers of all levels. Since 2015 we seek to make the engineering world fun, understandable and simple for everyone.**

**See us here:**

**[www.totemmaker.net](http://www.totemmaker.net)**

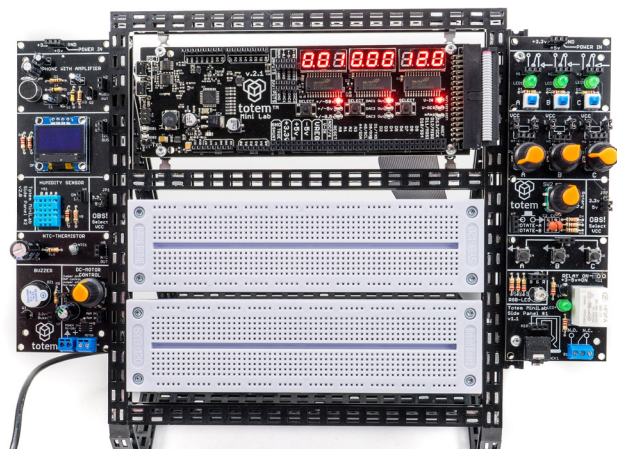
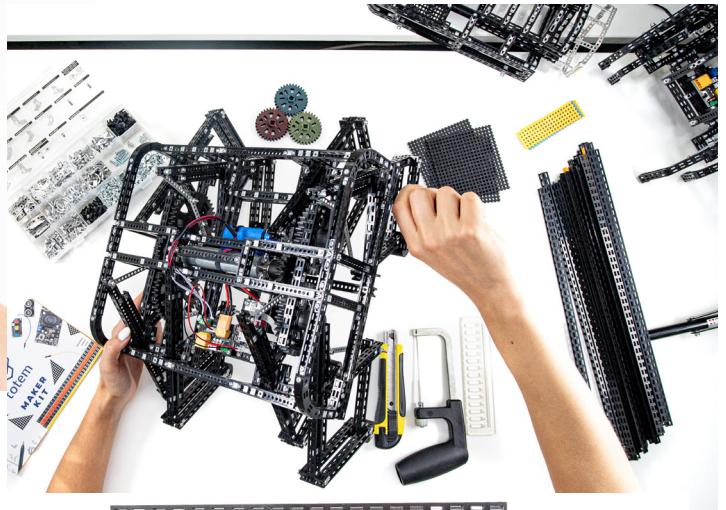
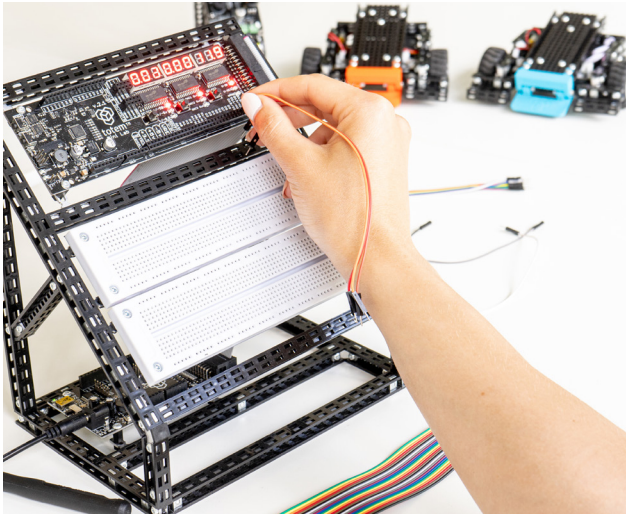

UAB Totem Technology  
Saulėtekio ave. 15, LT-10224, Vilnius, Lithuania  
T +370 682 99 076  
E [info@totemmaker.net](mailto:info@totemmaker.net)